

Planta 3

Andar Térreo



WWW.FOX-PLANNER.COM
felipearaujo@fox-planner.com
+351 912.601.241

Estatísticas

- 400 m²
- 3 Pisos
- 5 Dormitórios
- 4 Banheiros

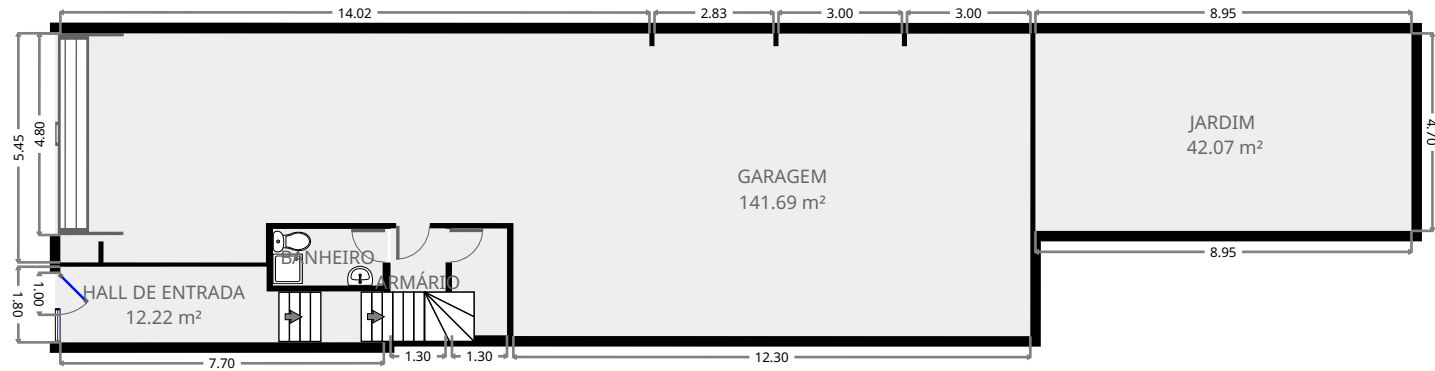

ESTA PLANTA É FORNECIDA SEM QUALQUER TIPO DE GARANTIA. A FOX PLANNER ESTÁ ISENTA DE QUALQUER GARANTIA, INCLUINDO, SEM LIMITAÇÕES, GARANTIAS DE SATISFAÇÃO E PRECISÃO DAS MEDIDAS.



Banheiro

Largura: 1.35 m
Comprimento: 2.60 m
Área: 3.52 m²
Perímetro: 7.91 m
Altura do teto: 2.80 m

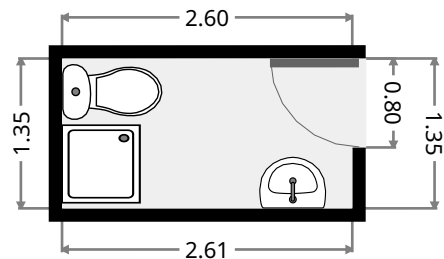

Jardim

Largura: 4.70 m
Comprimento: 8.95 m
Área: 42.07 m²
Perímetro: 27.30 m
Altura do teto: 2.80 m

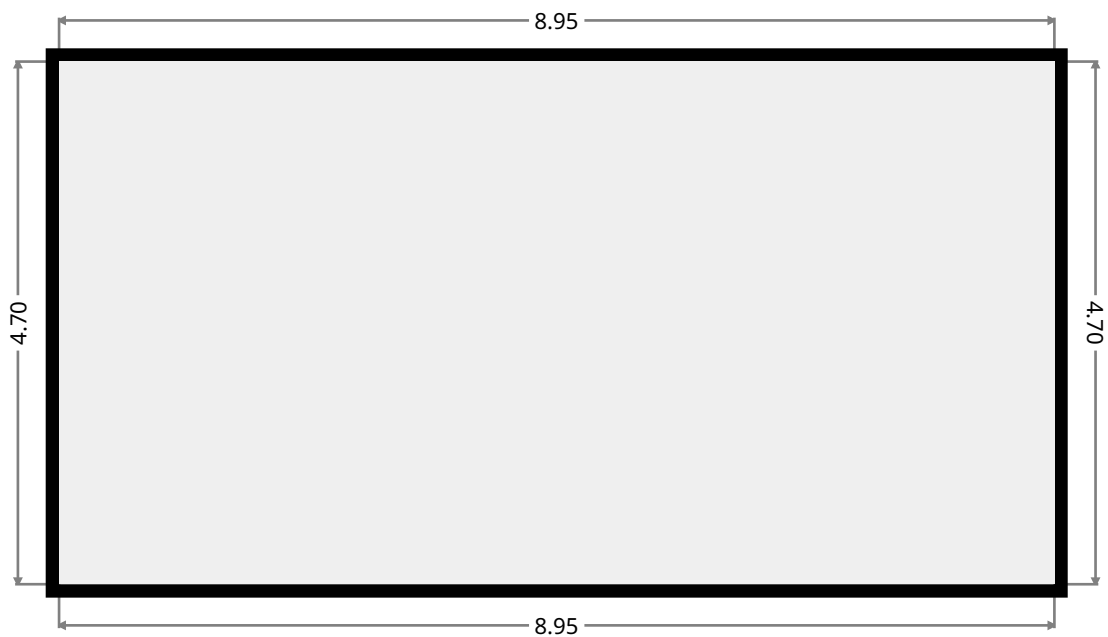

Garagem

Largura: 7.20 m
Comprimento: 23.09 m
Área: 141.69 m²
Perímetro: 65.26 m
Altura do teto: 2.80 m

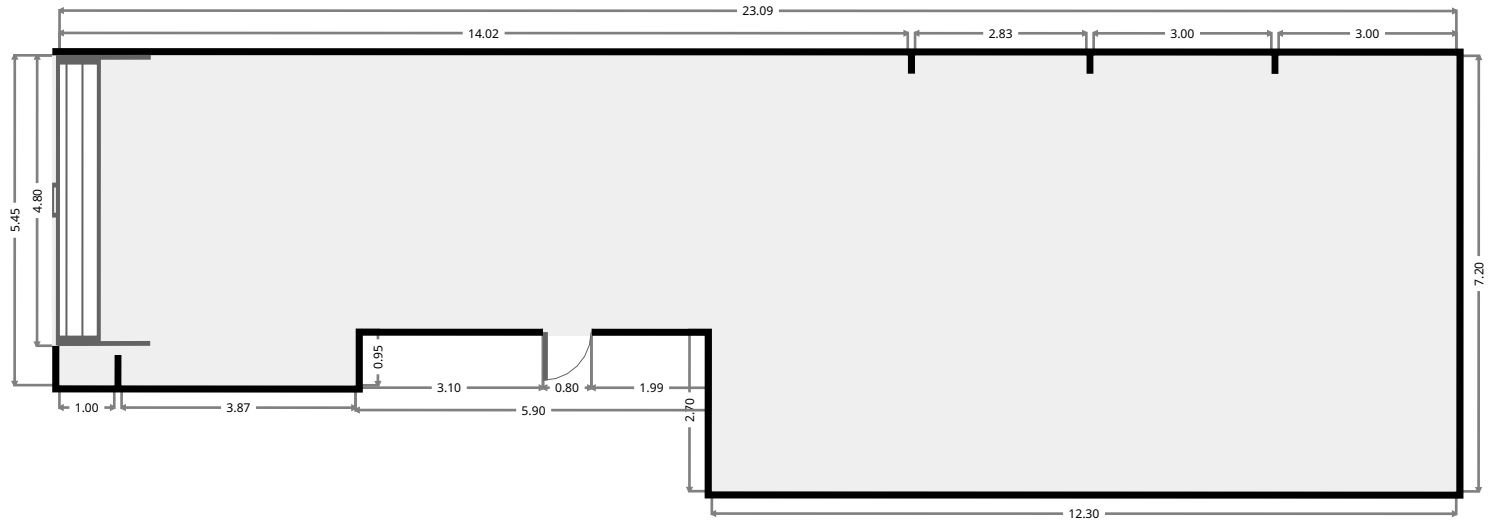
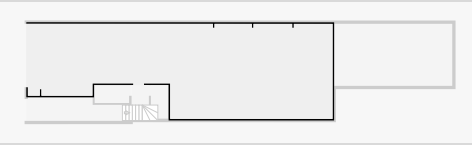

ESTA PLANTA É FORNECIDA SEM QUALQUER TIPO DE GARANTIA. A FOX PLANNER ESTÁ ISENTA DE QUALQUER GARANTIA, INCLUINDO, SEM LIMITAÇÕES, GARANTIAS DE SATISFAÇÃO E PRECISÃO DAS MEDIDAS.

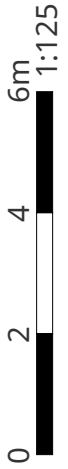

Clarabóia

Largura: 1.10 m
Comprimento: 5.00 m
Área: 5.50 m²
Perímetro: 12.20 m
Altura do teto: 2.80 m

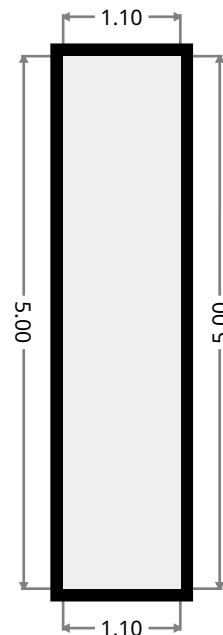

Armário

Largura: 1.30 m
Comprimento: 2.54 m
Área: 3.33 m²
Perímetro: 7.70 m
Altura do teto: 2.80 m

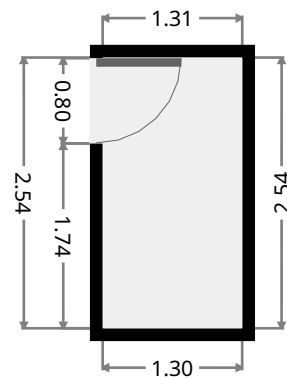
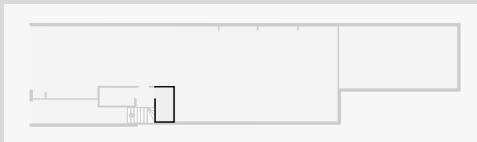

ESTA PLANTA É FORNECIDA SEM QUALQUER TIPO DE GARANTIA. A FOX PLANNER ESTÁ ISENTA DE QUALQUER GARANTIA, INCLUINDO, SEM LIMITAÇÕES, GARANTIAS DE SATISFAÇÃO E PRECISÃO DAS MEDIDAS.

Armário

Largura:	1.30 m
Comprimento:	2.55 m
Área:	3.34 m ²
Perímetro:	7.71 m
Altura do teto:	2.80 m

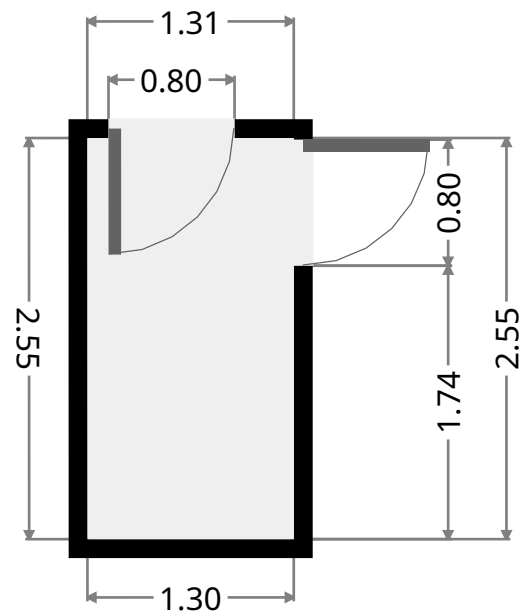

Hall de Entrada

Largura:	1.80 m
Comprimento:	7.70 m
Área:	12.22 m ²
Perímetro:	19.00 m
Altura do teto:	2.80 m

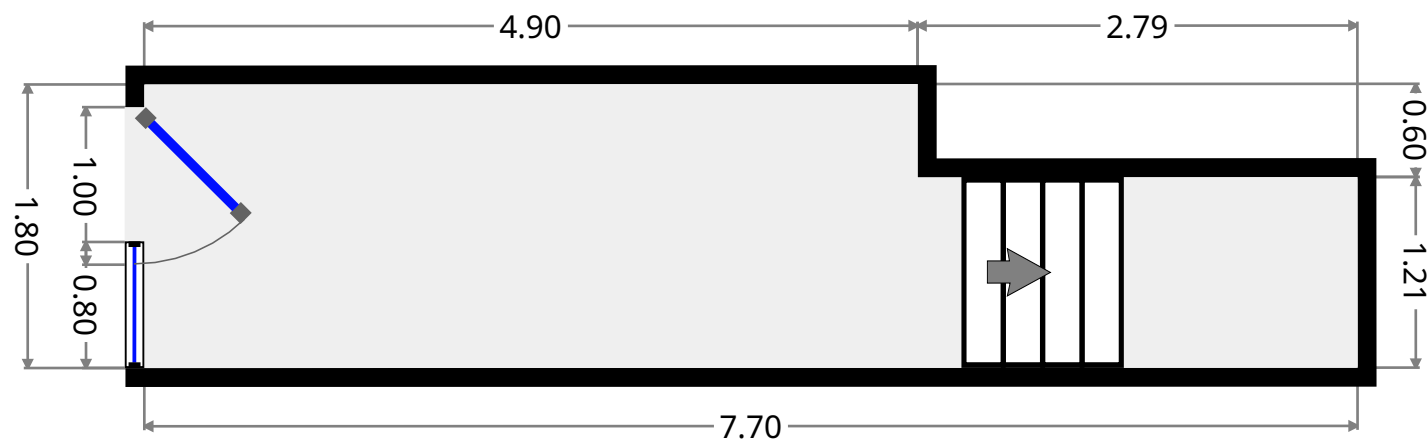

ESTA PLANTA É FORNECIDA SEM QUALQUER TIPO DE GARANTIA. A FOX PLANNER ESTÁ ISENTA DE QUALQUER GARANTIA, INCLUINDO, SEM LIMITAÇÕES, GARANTIAS DE SATISFAÇÃO E PRECISÃO DAS MEDIDAS.

0.0 0.5 1.0 1.5 2.0 2.5m 1:48

Planta 3

1º Piso



WWW.FOX-PLANNER.COM
felipearaujo@fox-planner.com
+351 912.601.241

Estatísticas

400 m²
3 Pisos
5 Dormitórios
4 Banheiros

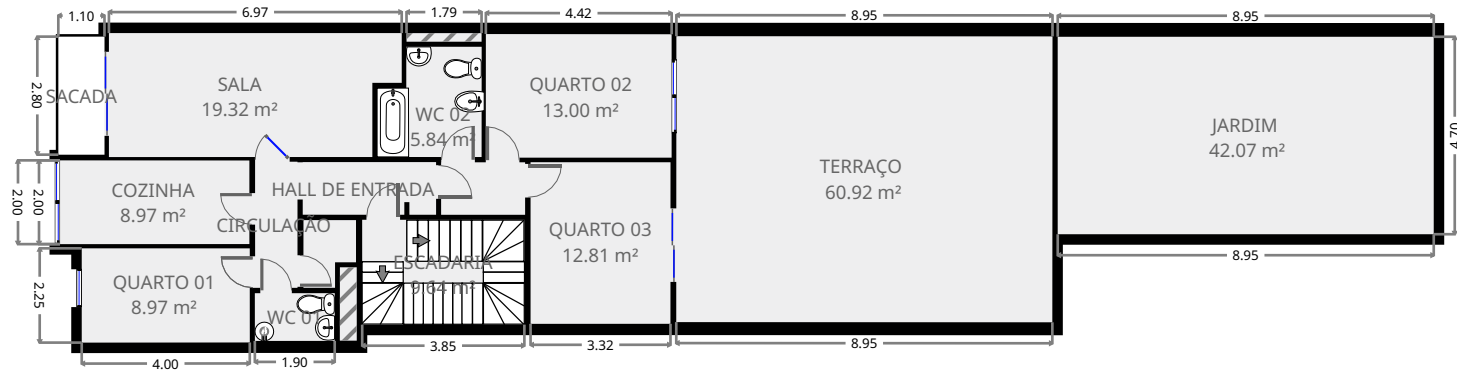

ESTA PLANTA É FORNECIDA SEM QUALQUER TIPO DE GARANTIA. A FOX PLANNER ESTÁ ISENTA DE QUALQUER GARANTIA, INCLUINDO, SEM LIMITAÇÕES, GARANTIAS DE SATISFAÇÃO E PRECISÃO DAS MEDIDAS.



Sala

Largura: 2.96 m
Comprimento: 6.97 m
Área: 19.32 m²
Perímetro: 19.84 m
Altura do teto: 2.80 m

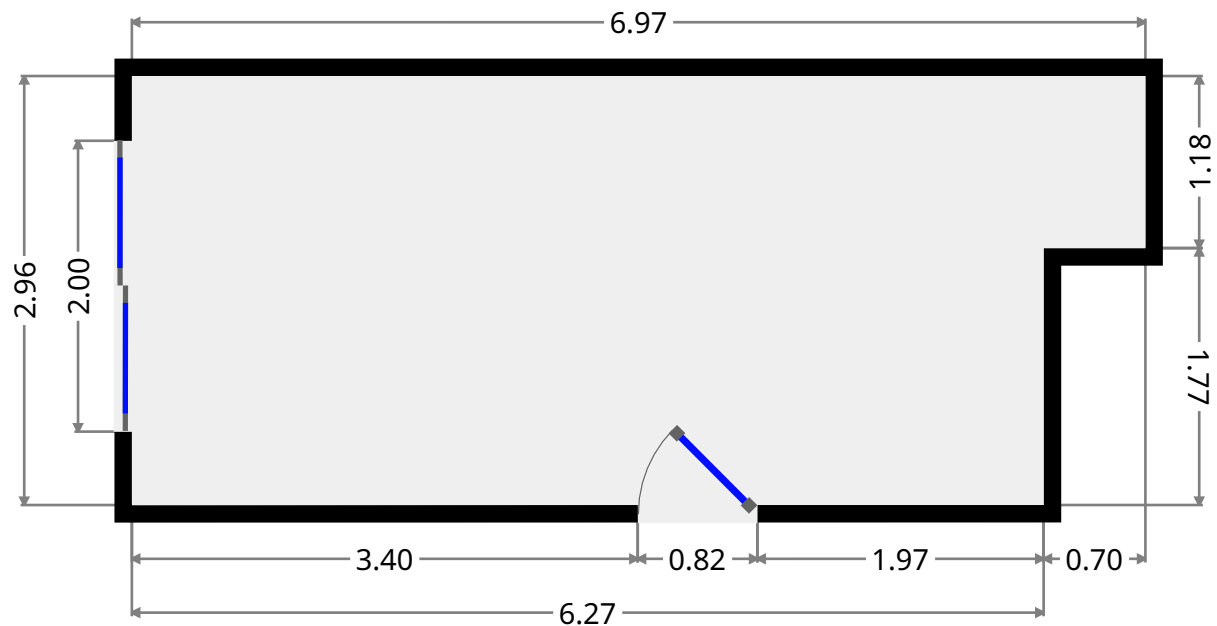
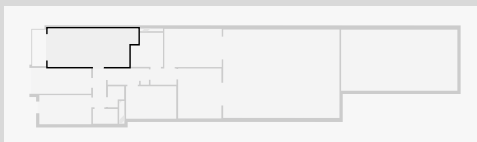

Sacada

Largura: 1.10 m
Comprimento: 2.81 m
Área: 3.09 m²
Perímetro: 7.82 m
Altura do teto: 2.80 m

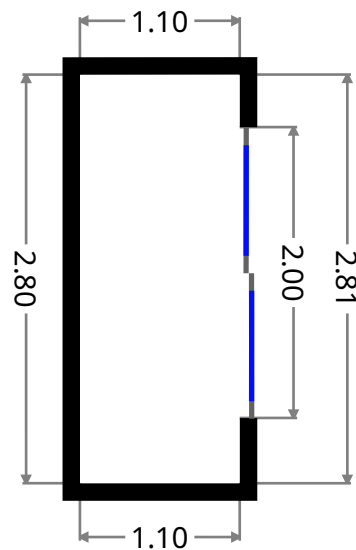
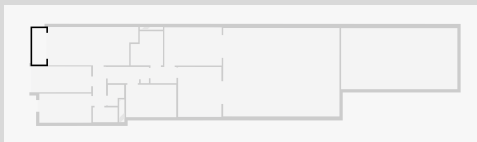

ESTA PLANTA É FORNECIDA SEM QUALQUER TIPO DE GARANTIA. A FOX PLANNER ESTÁ ISENTA DE QUALQUER GARANTIA, INCLUINDO, SEM LIMITAÇÕES, GARANTIAS DE SATISFAÇÃO E PRECISÃO DAS MEDIDAS.

Circulação

Largura:	1.00 m
Comprimento:	3.00 m
Área:	3.03 m ²
Perímetro:	8.02 m
Altura do teto:	2.80 m

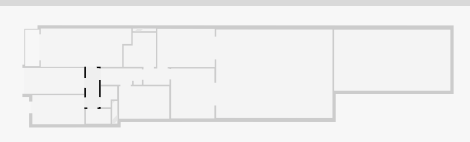

Cozinha

Largura:	1.99 m
Comprimento:	4.50 m
Área:	8.97 m ²
Perímetro:	13.00 m
Altura do teto:	2.80 m

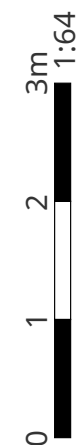
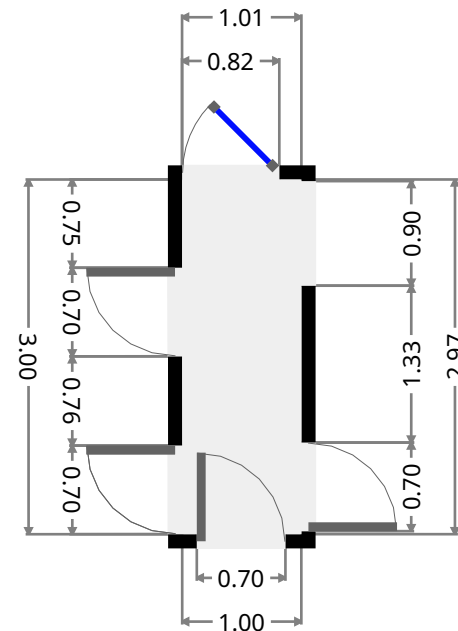
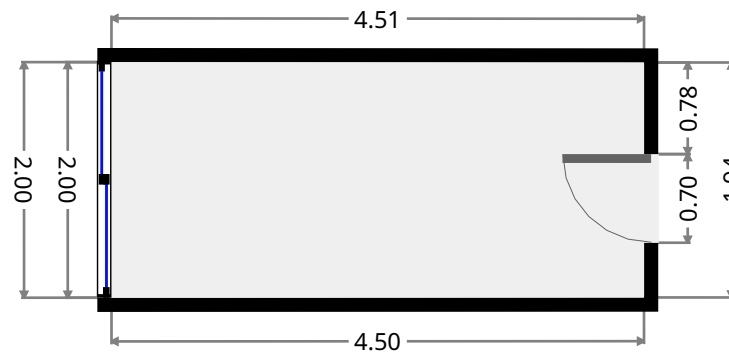
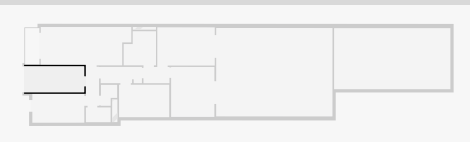

ESTA PLANTA É FORNECIDA SEM QUALQUER TIPO DE GARANTIA. A FOX PLANNER ESTÁ ISENTA DE QUALQUER GARANTIA, INCLUINDO, SEM LIMITAÇÕES, GARANTIAS DE SATISFAÇÃO E PRECISÃO DAS MEDIDAS.

Quarto 01

Largura: 2.24 m
Comprimento: 4.00 m
Área: 8.97 m²
Perímetro: 12.48 m
Altura do teto: 2.80 m

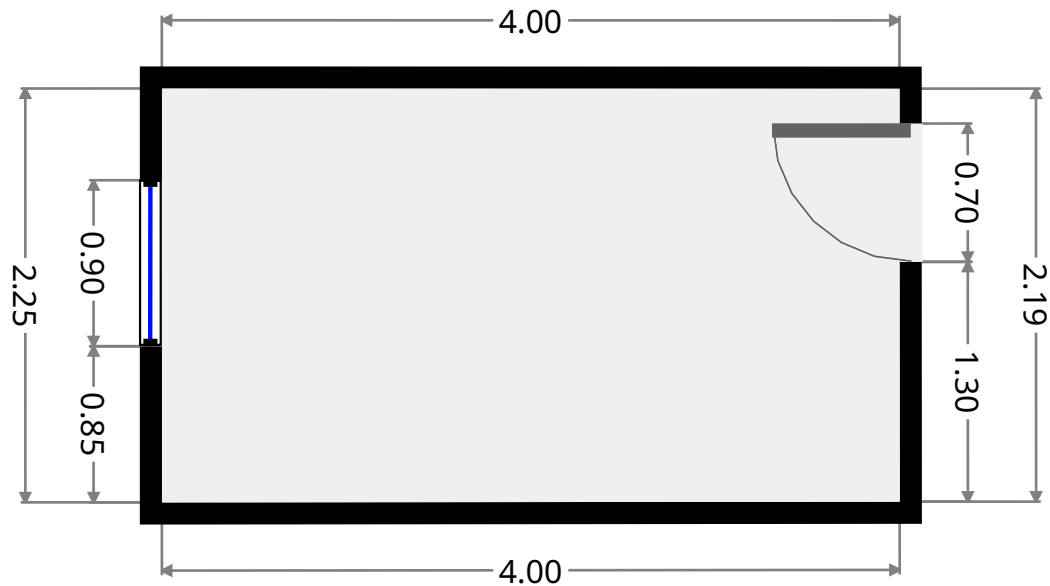
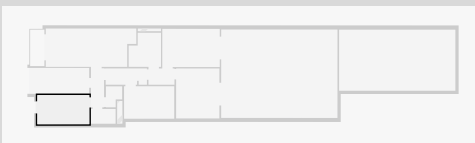

WC 01

Largura: 1.14 m
Comprimento: 1.90 m
Área: 2.16 m²
Perímetro: 6.07 m
Altura do teto: 2.80 m

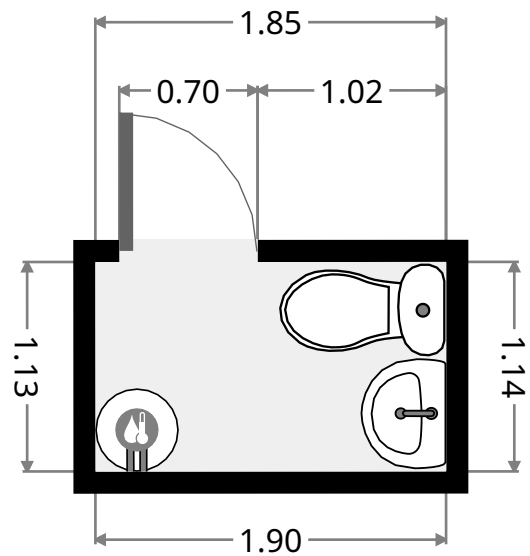
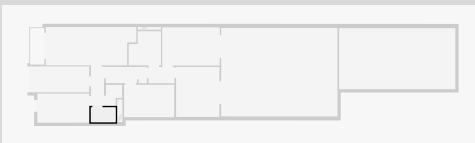

ESTA PLANTA É FORNECIDA SEM QUALQUER TIPO DE GARANTIA. A FOX PLANNER ESTÁ ISENTA DE QUALQUER GARANTIA, INCLUINDO, SEM LIMITAÇÕES, GARANTIAS DE SATISFAÇÃO E PRECISÃO DAS MEDIDAS.

Armário

Largura:	1.24 m
Comprimento:	1.61 m
Área:	1.71 m ²
Perímetro:	5.72 m
Altura do teto:	2.80 m

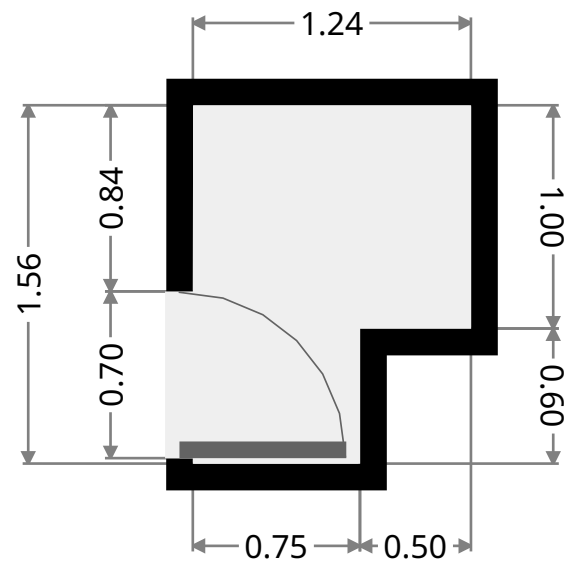
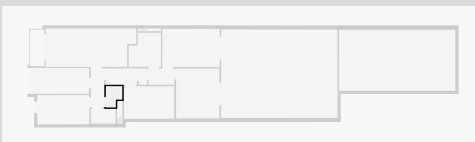

Hall de Entrada

Largura:	1.25 m
Comprimento:	3.17 m
Área:	3.94 m ²
Perímetro:	9.45 m
Altura do teto:	2.80 m

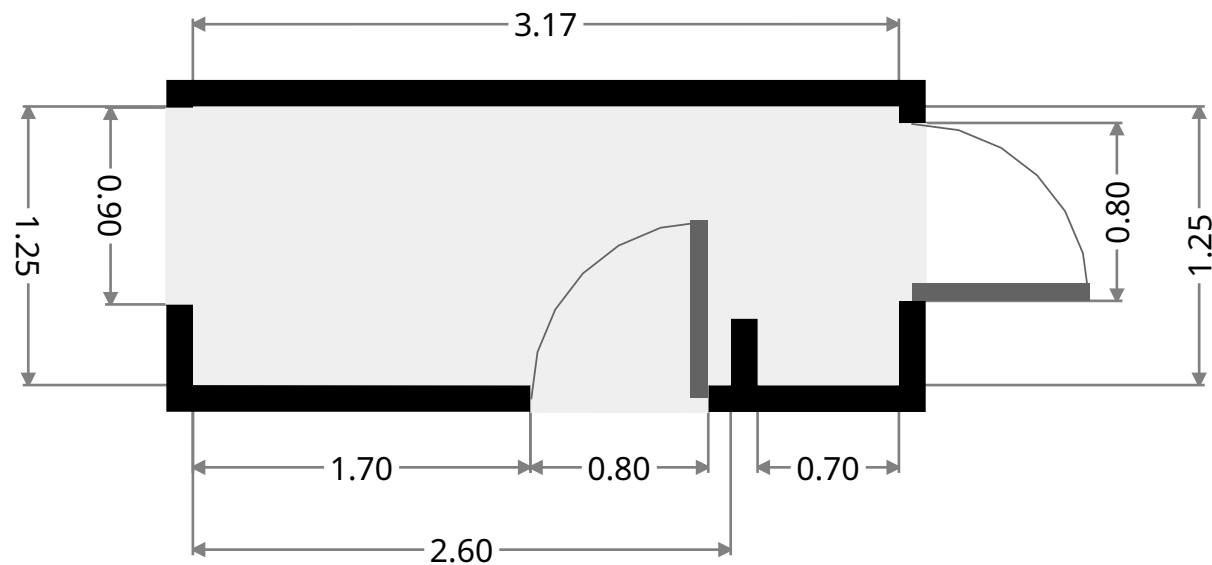
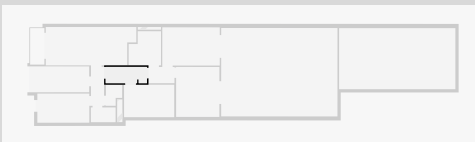

Hall dos Quartos

Largura: 1.25 m
Comprimento: 2.00 m
Área: 2.50 m²
Perímetro: 6.50 m
Altura do teto: 2.80 m

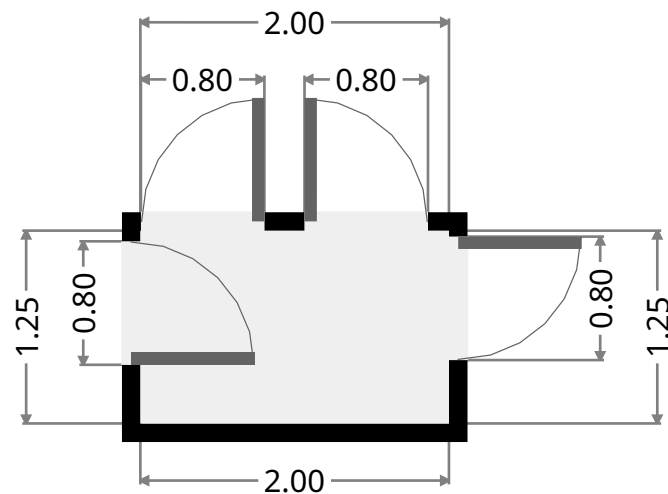
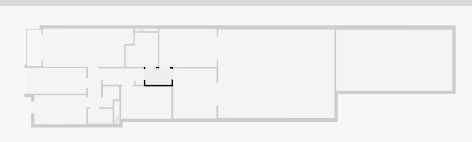

WC 02

Largura: 2.49 m
Comprimento: 2.62 m
Área: 5.84 m²
Perímetro: 10.23 m
Altura do teto: 2.80 m

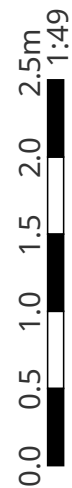
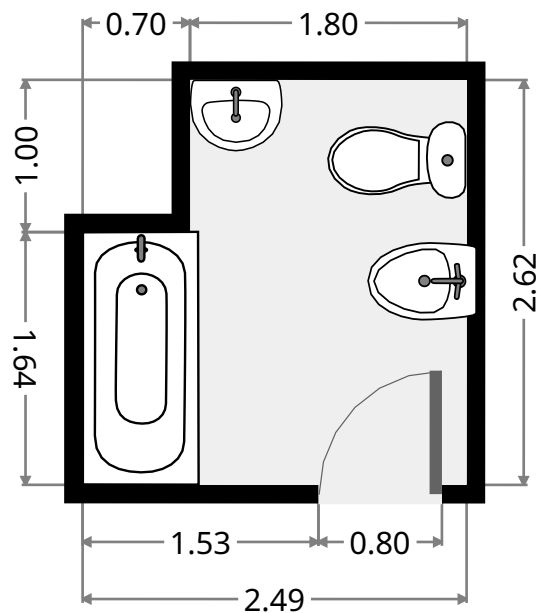
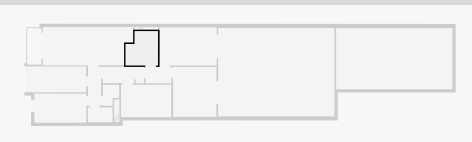

ESTA PLANTA É FORNECIDA SEM QUALQUER TIPO DE GARANTIA. A FOX PLANNER ESTÁ ISENTA DE QUALQUER GARANTIA, INCLUINDO, SEM LIMITAÇÕES, GARANTIAS DE SATISFAÇÃO E PRECISÃO DAS MEDIDAS.

Quarto 02

Largura: 2.94 m
Comprimento: 4.43 m
Área: 13.00 m²
Perímetro: 14.72 m
Altura do teto: 2.80 m

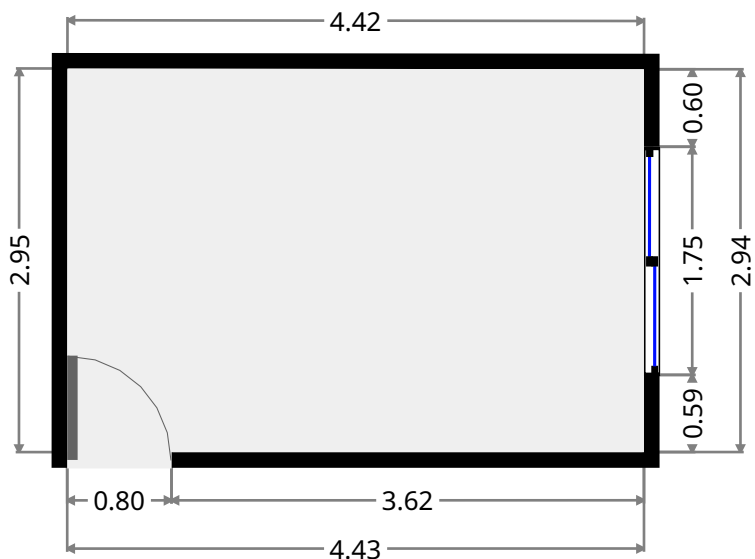
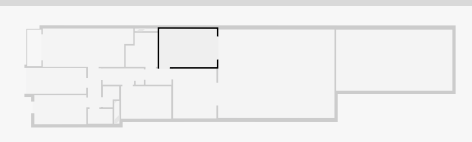

Quarto 03

Largura: 3.32 m
Comprimento: 3.84 m
Área: 12.81 m²
Perímetro: 14.35 m
Altura do teto: 2.80 m

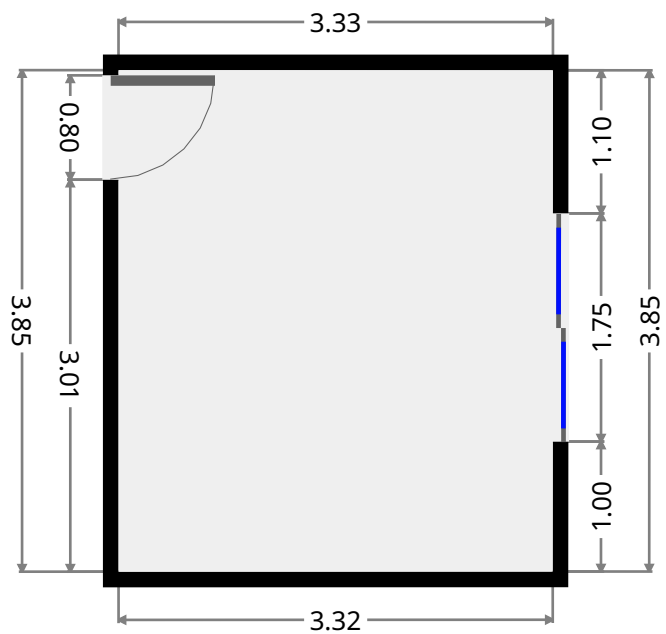
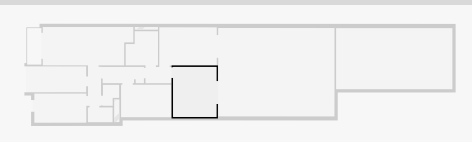

ESTA PLANTA É FORNECIDA SEM QUALQUER TIPO DE GARANTIA. A FOX PLANNER ESTÁ ISENTA DE QUALQUER GARANTIA, INCLUINDO, SEM LIMITAÇÕES, GARANTIAS DE SATISFAÇÃO E PRECISÃO DAS MEDIDAS.

Terraço

Largura: 6.81 m
Comprimento: 8.95 m
Área: 60.92 m²
Perímetro: 31.52 m
Altura do teto: 2.80 m

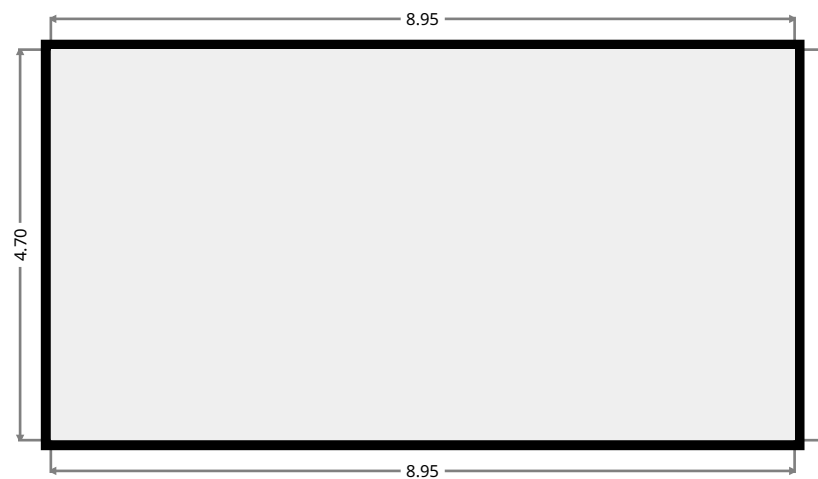
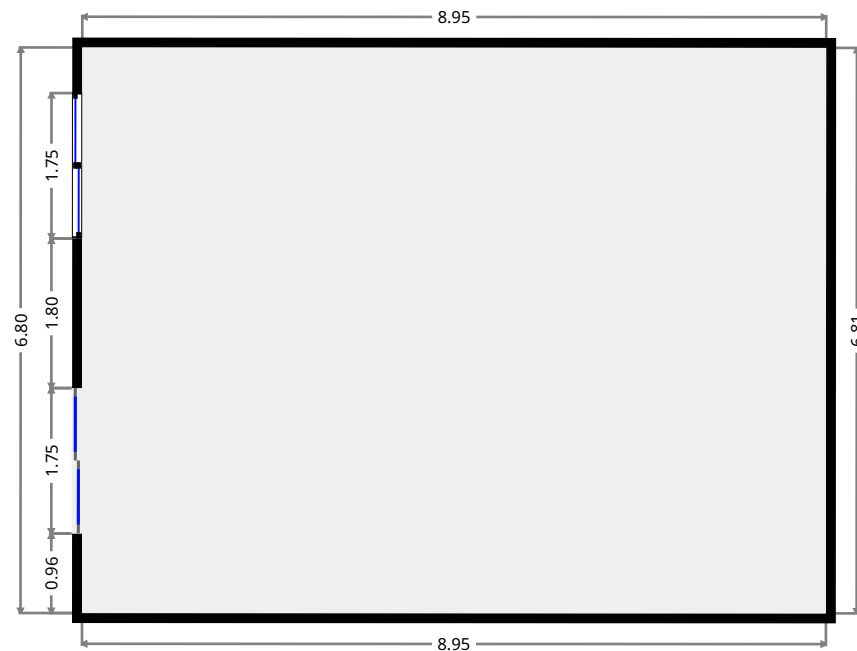
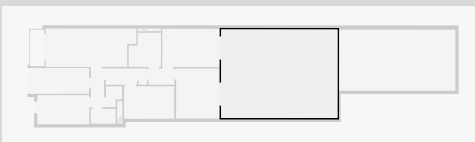

Jardim

Largura: 4.70 m
Comprimento: 8.95 m
Área: 42.07 m²
Perímetro: 27.30 m
Altura do teto: 2.80 m

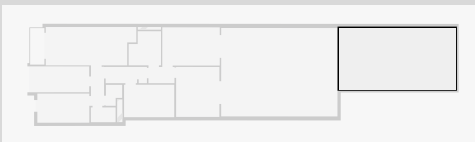

ESTA PLANTA É FORNECIDA SEM QUALQUER TIPO DE GARANTIA. A FOX PLANNER ESTÁ ISENTA DE QUALQUER GARANTIA, INCLUINDO, SEM LIMITAÇÕES, GARANTIAS DE SATISFAÇÃO E PRECISÃO DAS MEDIDAS.

Escadaria

Largura: 2.50 m
Comprimento: 3.85 m
Área: 9.64 m²
Perímetro: 12.72 m
Altura do teto: 2.80 m

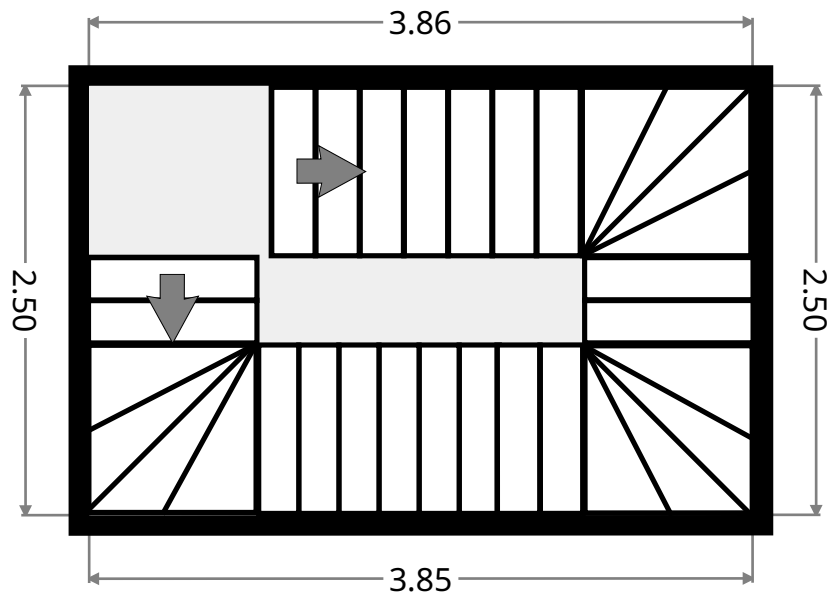
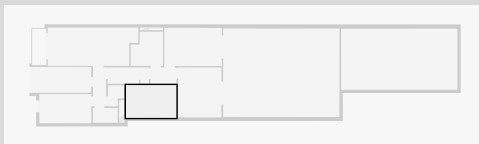

ESTA PLANTA É FORNECIDA SEM QUALQUER TIPO DE GARANTIA. A FOX PLANNER ESTÁ ISENTA DE QUALQUER GARANTIA, INCLUINDO, SEM LIMITAÇÕES, GARANTIAS DE SATISFAÇÃO E PRECISÃO DAS MEDIDAS.

Planta 3

3º Piso



WWW.FOX-PLANNER.COM
felipearaujo@fox-planner.com
+351 912.601.241

Estatísticas

400 m²
3 Pisos
5 Dormitórios
4 Banheiros

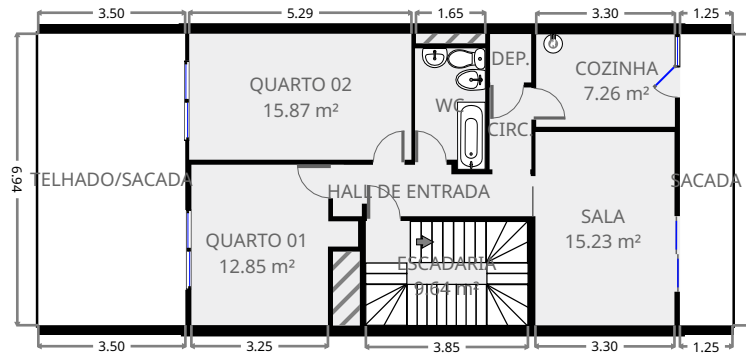

ESTA PLANTA É FORNECIDA SEM QUALQUER TIPO DE GARANTIA. A FOX PLANNER ESTÁ ISENTA DE QUALQUER GARANTIA, INCLUINDO, SEM LIMITAÇÕES, GARANTIAS DE SATISFAÇÃO E PRECISÃO DAS MEDIDAS.



Hall de Entrada

Largura: 1.22 m
Comprimento: 4.71 m
Área: 5.30 m²
Perímetro: 12.46 m
Altura do teto: 2.80 m

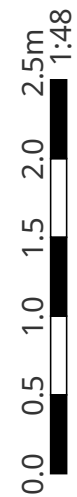
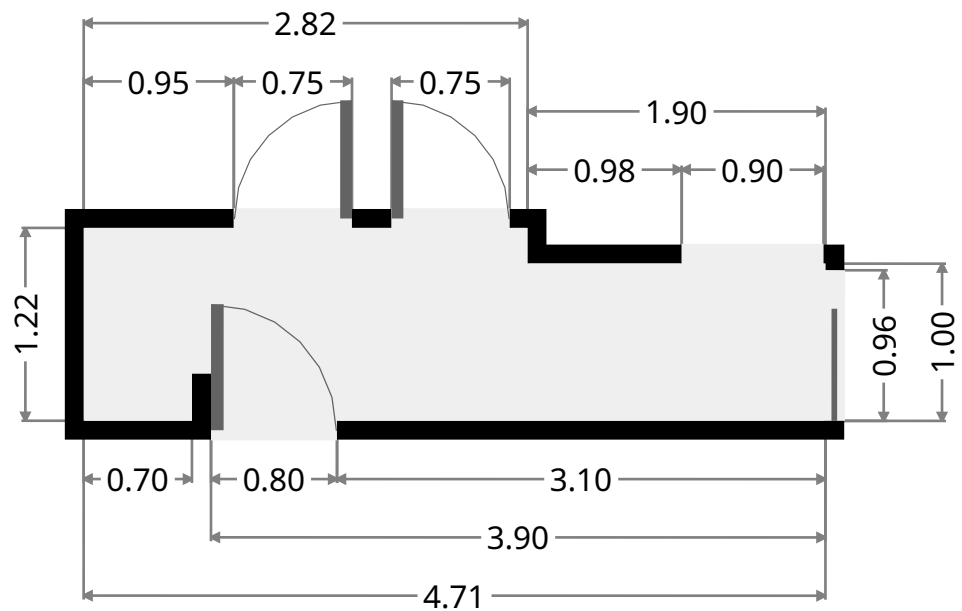
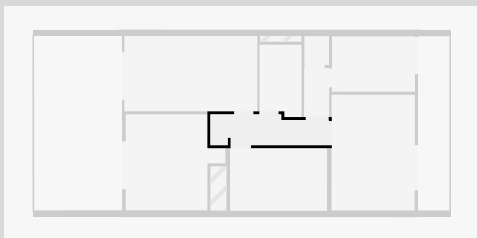

ESTA PLANTA É FORNECIDA SEM QUALQUER TIPO DE GARANTIA. A FOX PLANNER ESTÁ ISENTA DE QUALQUER GARANTIA, INCLUINDO, SEM LIMITAÇÕES, GARANTIAS DE SATISFAÇÃO E PRECISÃO DAS MEDIDAS.

Quarto 01

Largura: 3.82 m
Comprimento: 3.97 m
Área: 12.85 m²
Perímetro: 15.57 m
Altura do teto: 2.80 m

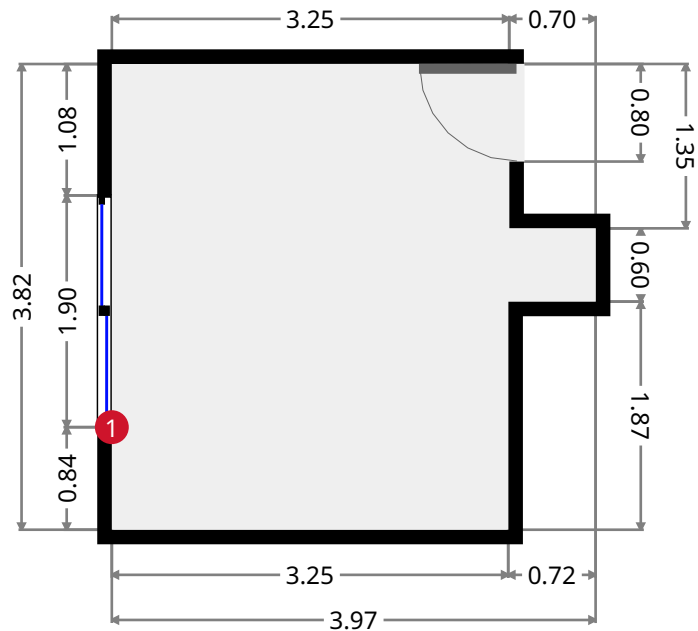
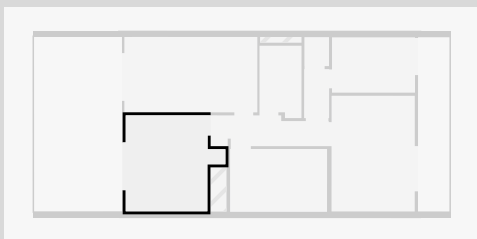

1



Janela de Correr

- Altura: 0.80 m

- Distância até ao Chão: 1.30 m

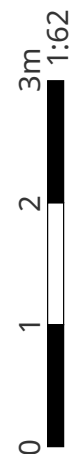

ESTA PLANTA É FORNECIDA SEM QUALQUER TIPO DE GARANTIA. A FOX PLANNER ESTÁ ISENTA DE QUALQUER GARANTIA, INCLUINDO, SEM LIMITAÇÕES, GARANTIAS DE SATISFAÇÃO E PRECISÃO DAS MEDIDAS.

Quarto 02

Largura: 3.00 m
Comprimento: 5.29 m
Área: 15.87 m²
Perímetro: 16.58 m
Altura do teto: 2.80 m

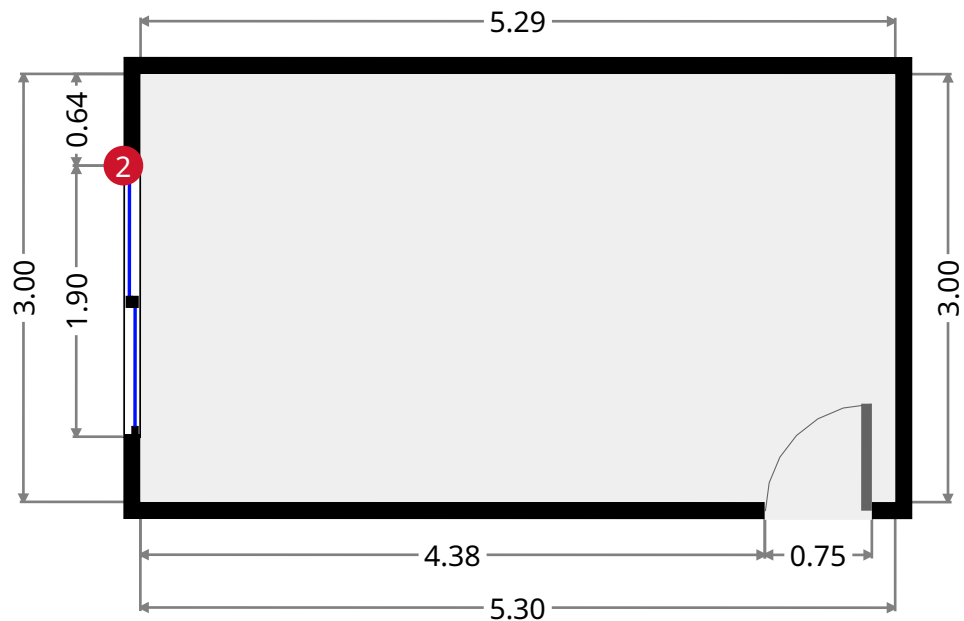
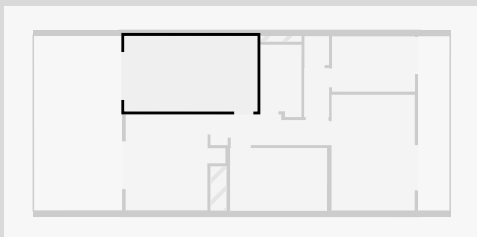

2



Janela de Correr

- Altura: 0.80 m

- Distância até ao Chão: 1.30 m



ESTA PLANTA É FORNECIDA SEM QUALQUER TIPO DE GARANTIA. A FOX PLANNER ESTÁ ISENTA DE QUALQUER GARANTIA, INCLUINDO, SEM LIMITAÇÕES, GARANTIAS DE SATISFAÇÃO E PRECISÃO DAS MEDIDAS.

WC

Largura:	1.68 m
Comprimento:	2.88 m
Área:	4.57 m ²
Perímetro:	9.10 m
Altura do teto:	2.80 m

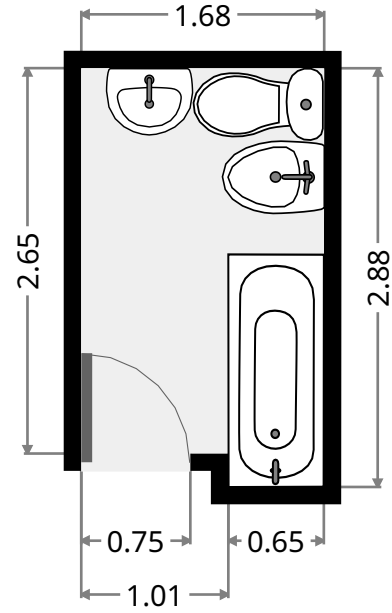
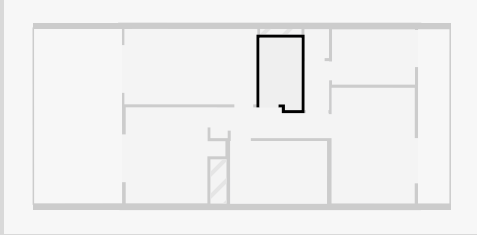

Circ.

Largura:	0.99 m
Comprimento:	1.95 m
Área:	1.94 m ²
Perímetro:	5.89 m
Altura do teto:	2.80 m

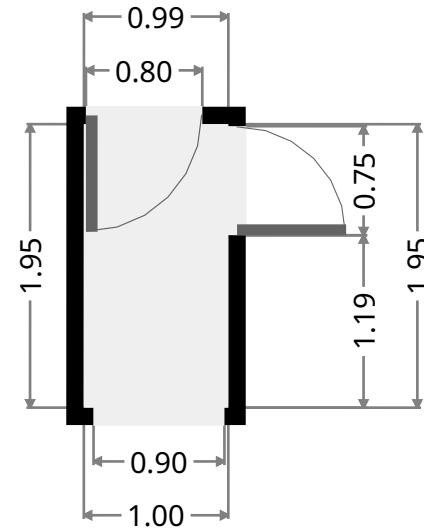
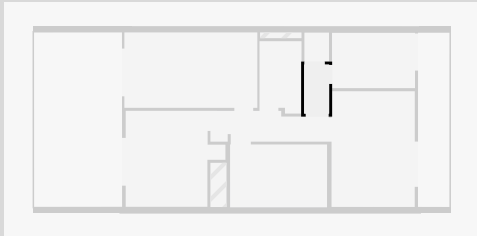

ESTA PLANTA É FORNECIDA SEM QUALQUER TIPO DE GARANTIA. A FOX PLANNER ESTÁ ISENTA DE QUALQUER GARANTIA, INCLUINDO, SEM LIMITAÇÕES, GARANTIAS DE SATISFAÇÃO E PRECISÃO DAS MEDIDAS.



Dep.

Largura: 0.98 m
Comprimento: 1.15 m
Área: 1.13 m²
Perímetro: 4.26 m
Altura do teto: 2.80 m

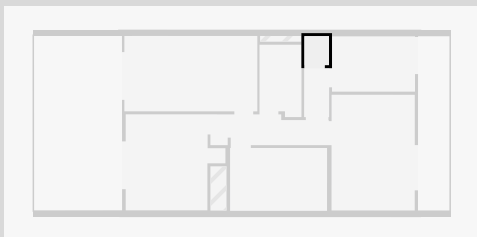

Cozinha

Largura: 2.20 m
Comprimento: 3.30 m
Área: 7.26 m²
Perímetro: 11.00 m
Altura do teto: 2.80 m

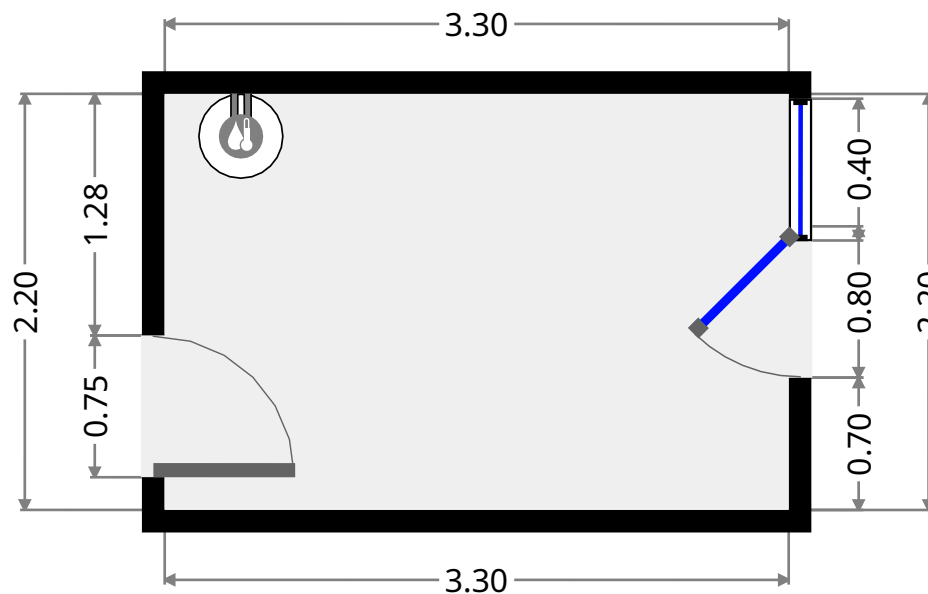
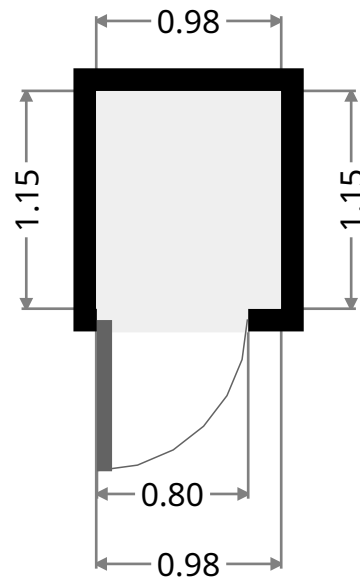
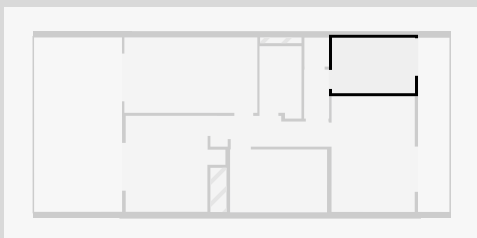

ESTA PLANTA É FORNECIDA SEM QUALQUER TIPO DE GARANTIA. A FOX PLANNER ESTÁ ISENTA DE QUALQUER GARANTIA, INCLUINDO, SEM LIMITAÇÕES, GARANTIAS DE SATISFAÇÃO E PRECISÃO DAS MEDIDAS.

Sala

Largura: 3.31 m
Comprimento: 4.60 m
Área: 15.23 m²
Perímetro: 15.82 m
Altura do teto: 2.80 m

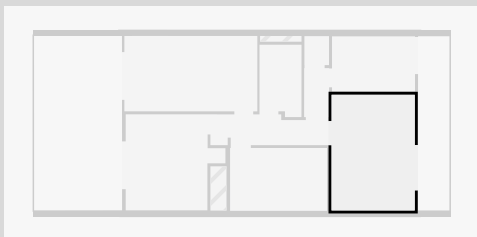

Sacada

Largura: 1.25 m
Comprimento: 6.93 m
Área: 8.67 m²
Perímetro: 16.36 m
Altura do teto: 2.80 m

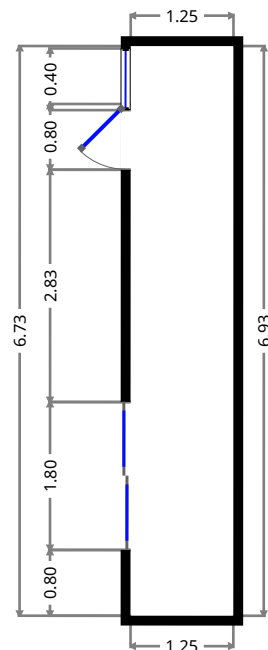
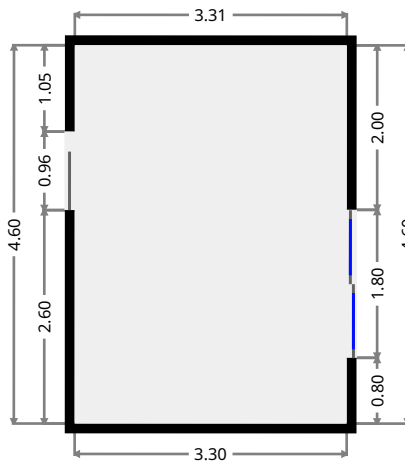
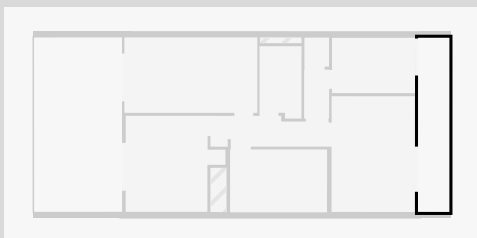

ESTA PLANTA É FORNECIDA SEM QUALQUER TIPO DE GARANTIA. A FOX PLANNER ESTÁ ISENTA DE QUALQUER GARANTIA, INCLUINDO, SEM LIMITAÇÕES, GARANTIAS DE SATISFAÇÃO E PRECISÃO DAS MEDIDAS.

Telhado/Sacada

Largura: 3.50 m
Comprimento: 6.94 m
Área: 24.27 m²
Perímetro: 20.87 m
Altura do teto: 2.80 m

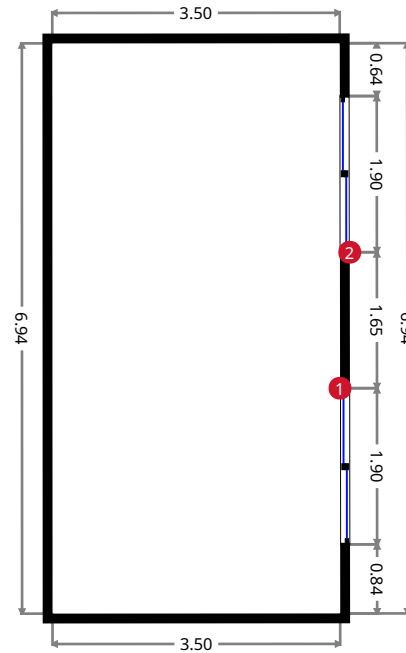
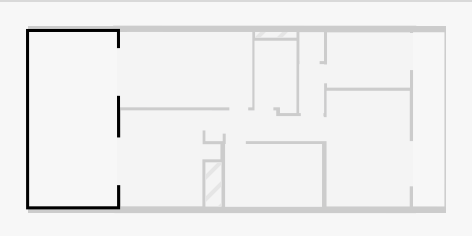

1



Janela de Correr

- Altura: 0.80 m

- Distância até ao Chão: 1.30 m

2



Janela de Correr

- Altura: 0.80 m

- Distância até ao Chão: 1.30 m

Escadaria

Largura: 2.50 m
Comprimento: 3.85 m
Área: 9.64 m²
Perímetro: 12.71 m
Altura do teto: 2.80 m

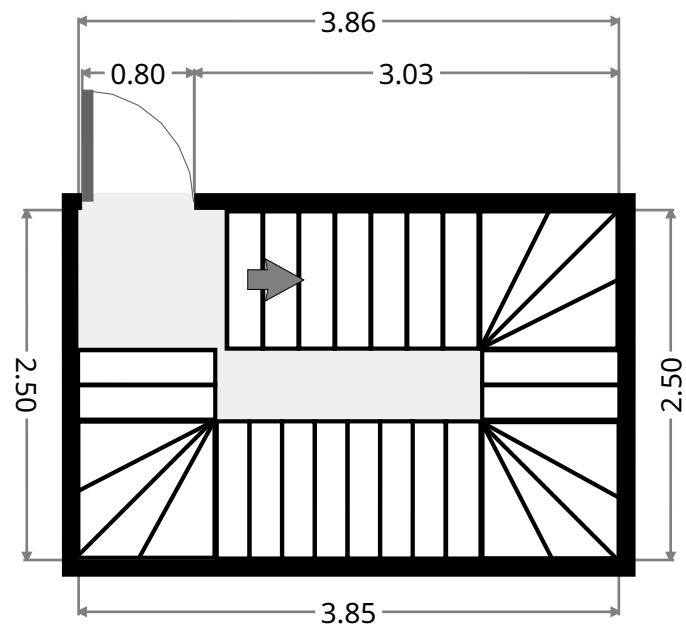
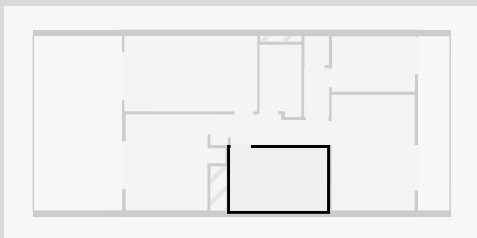

ESTA PLANTA É FORNECIDA SEM QUALQUER TIPO DE GARANTIA. A FOX PLANNER ESTÁ ISENTA DE QUALQUER GARANTIA, INCLUINDO, SEM LIMITAÇÕES, GARANTIAS DE SATISFAÇÃO E PRECISÃO DAS MEDIDAS.